

800x2000mm

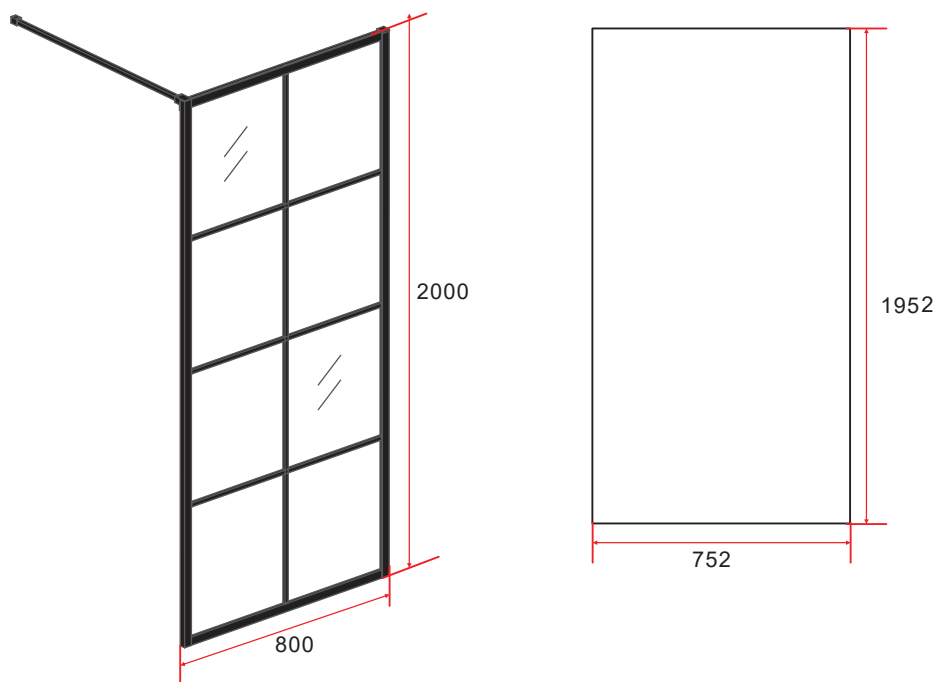

TECHNICAL DRAWING

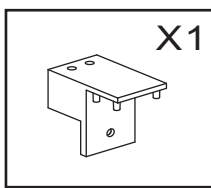

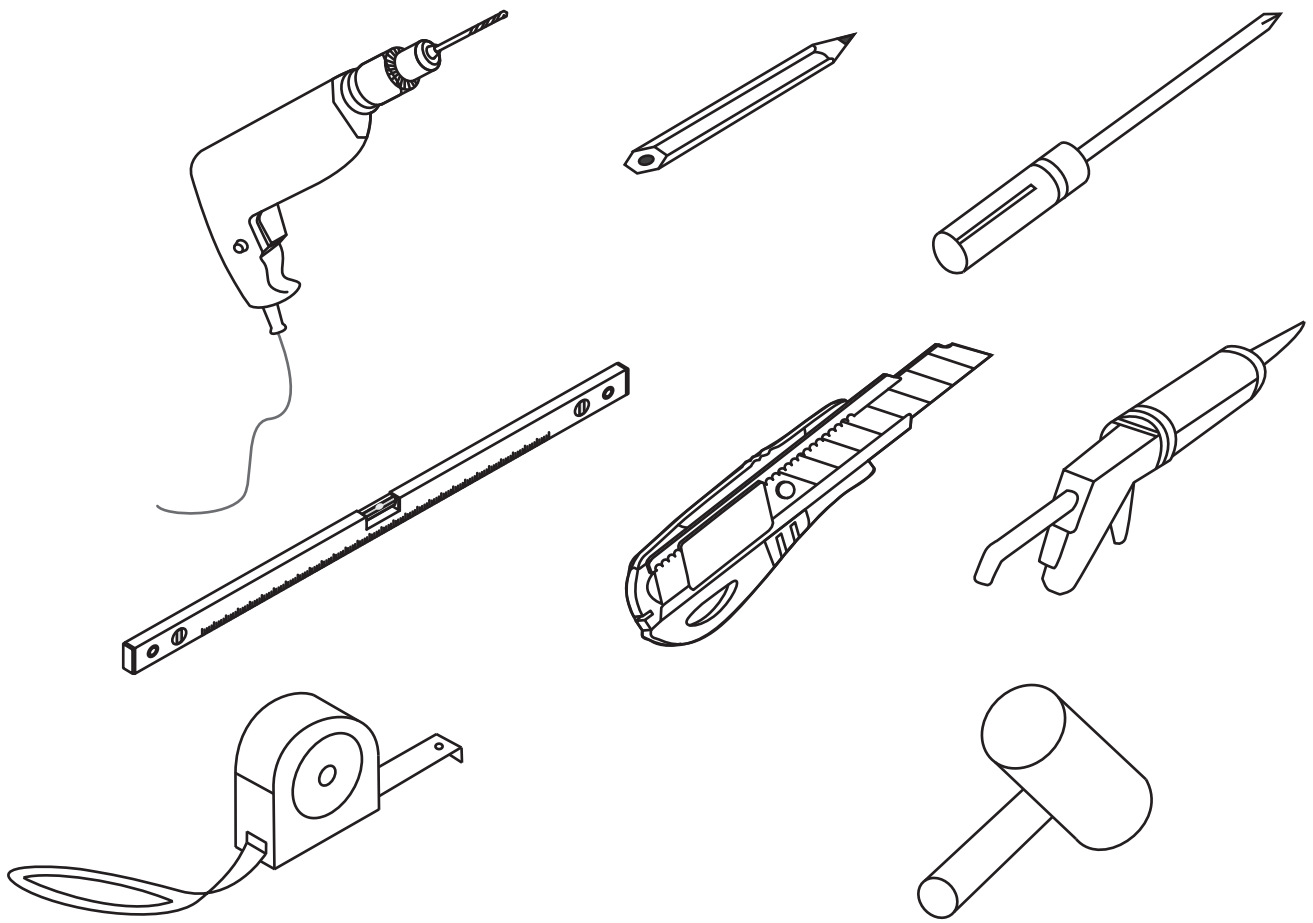

PJ-4230

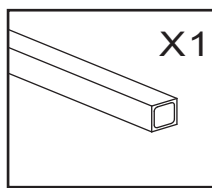

LG-04

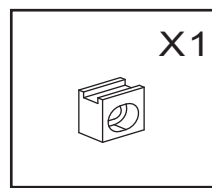

PJ-4207

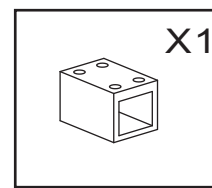

PJ-4206

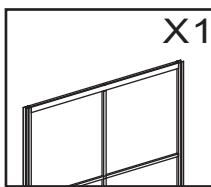

GLASS

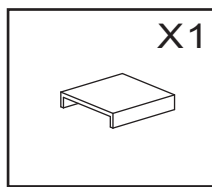

KQ-47cover

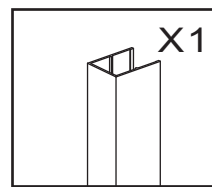

BK-25

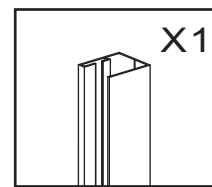

KQ-47

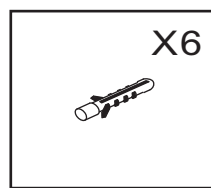

PJ-4606

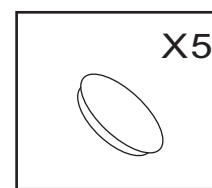
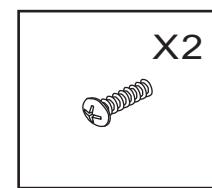
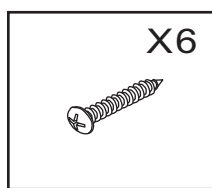

Drawing the install size.

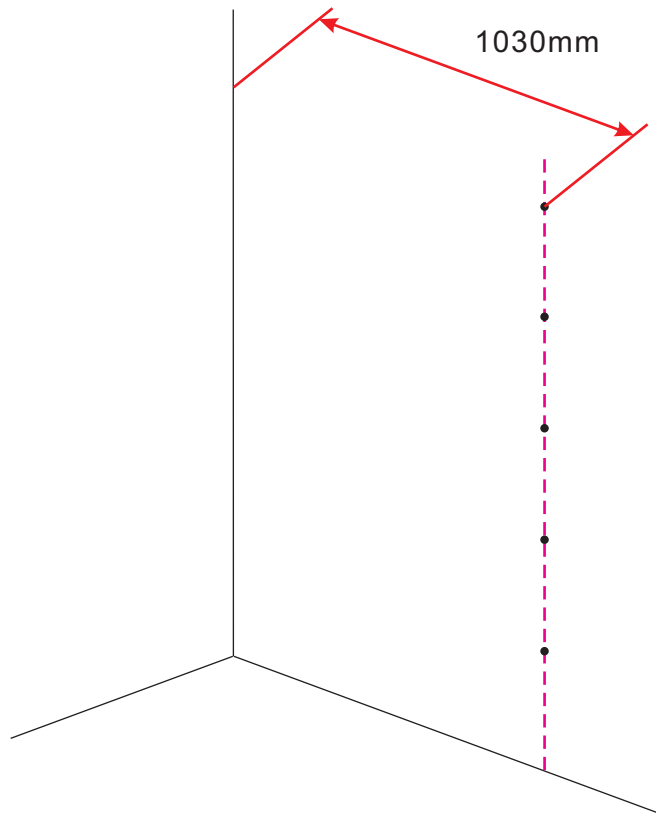

1

Install the wall profile.

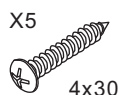
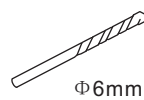
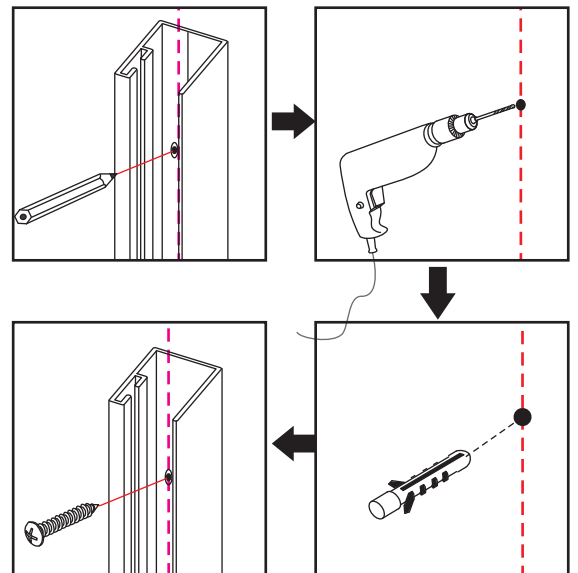
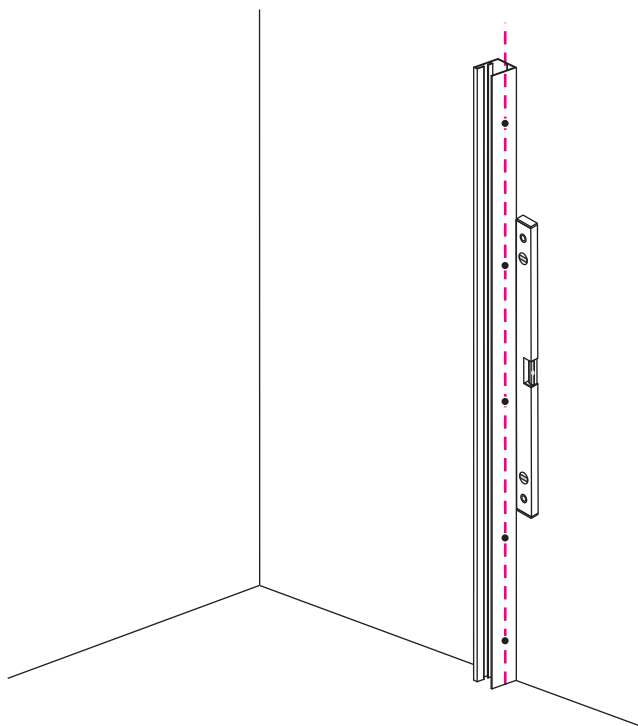

2

Install the fixed glass.

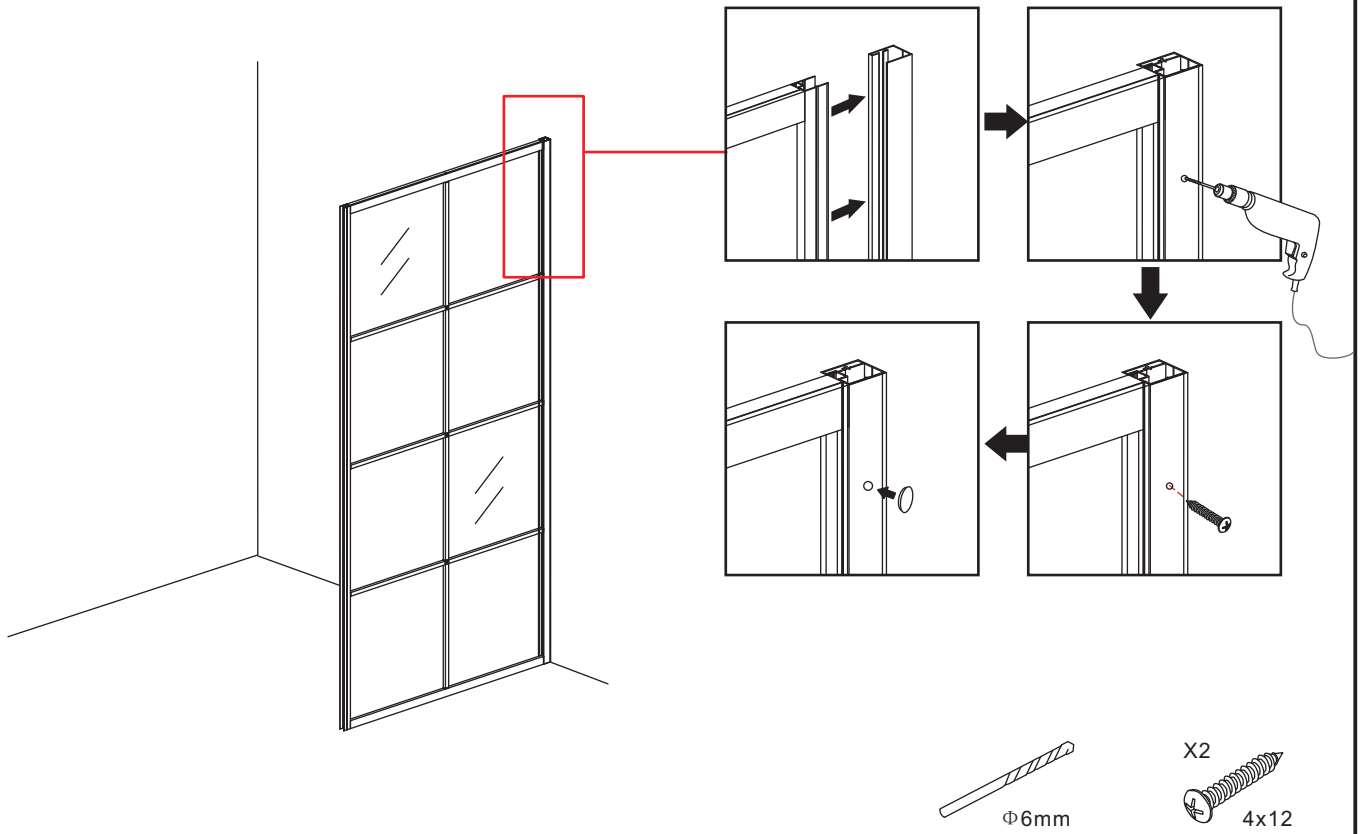

3

Install the frame profile of broadside fixed glass.

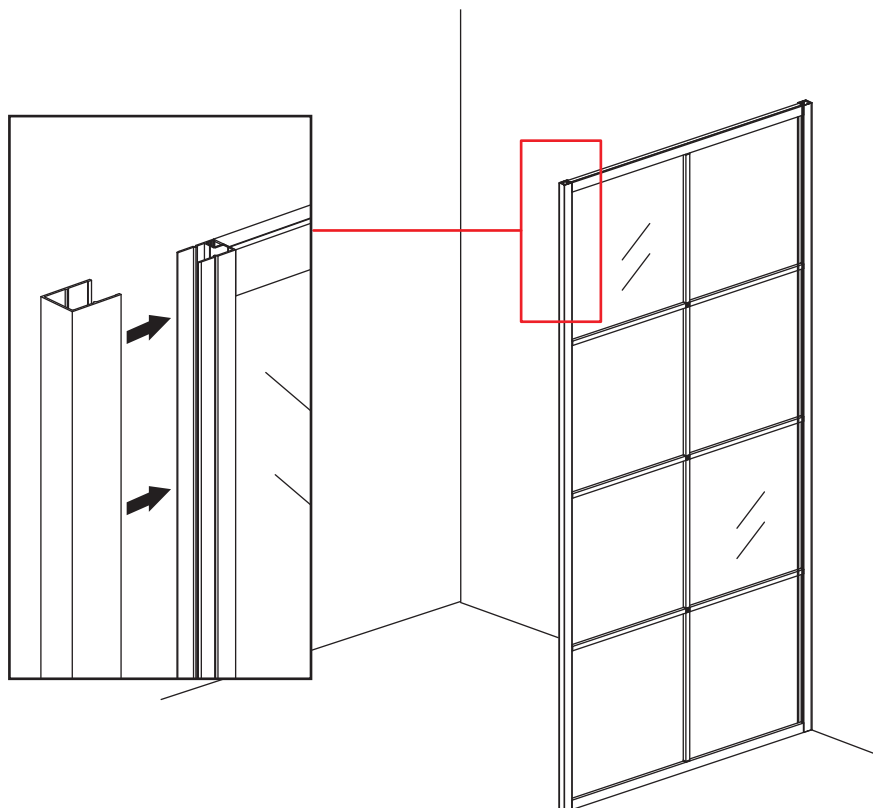

4

Install the support bar on the wall.

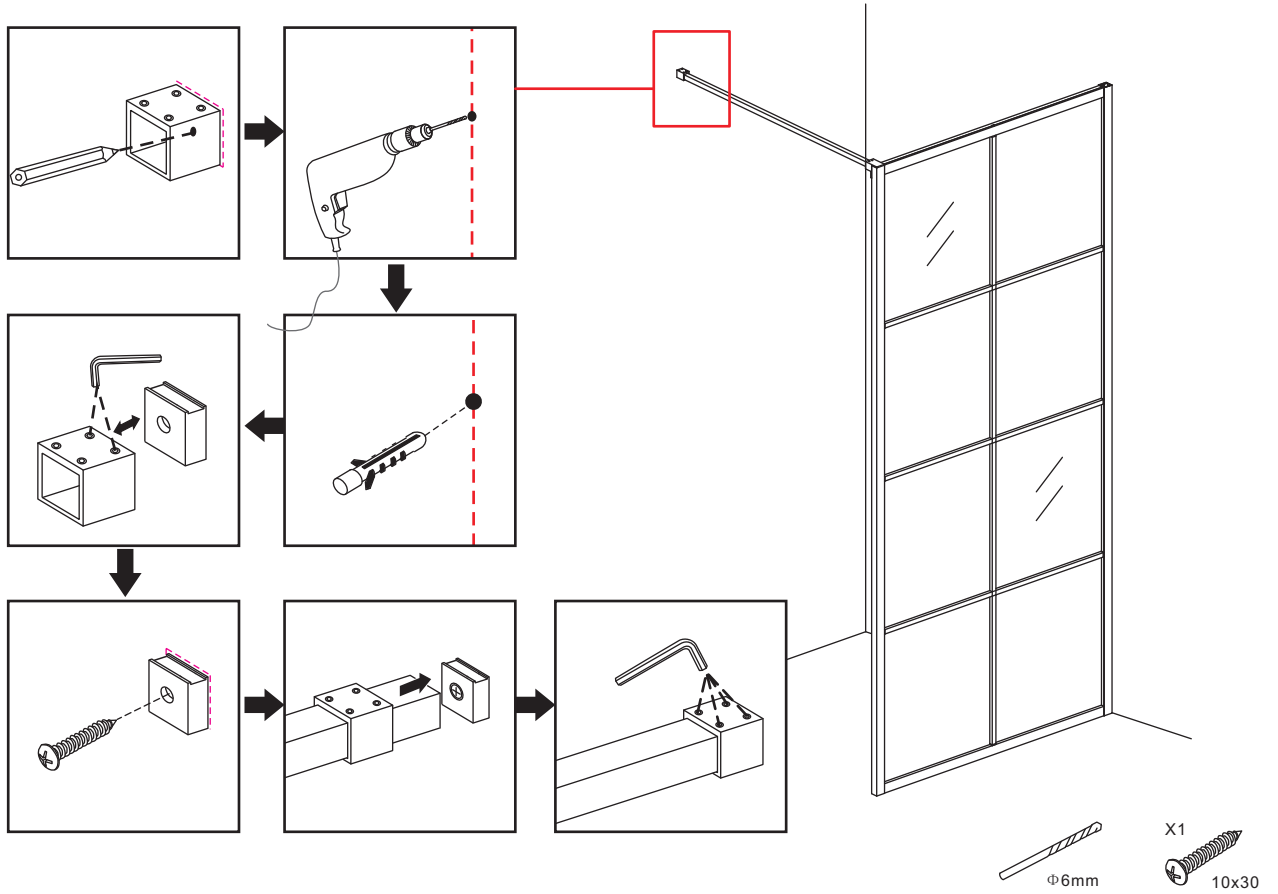

Install the support bar part on glass.

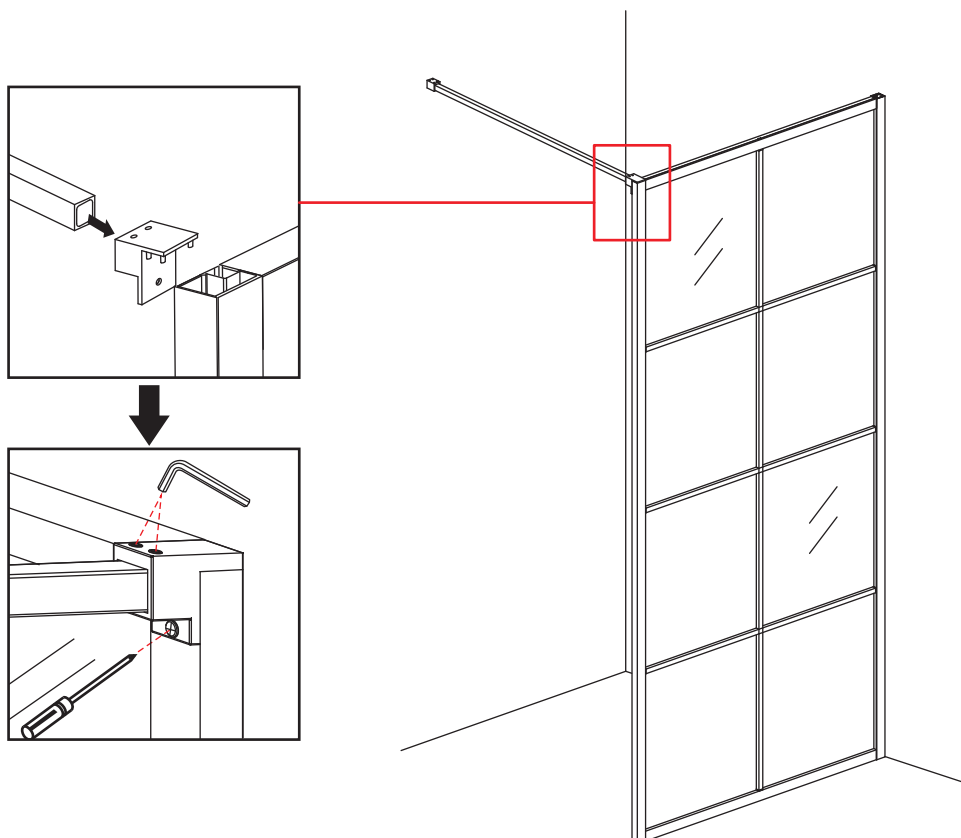

Install the top decorate part.

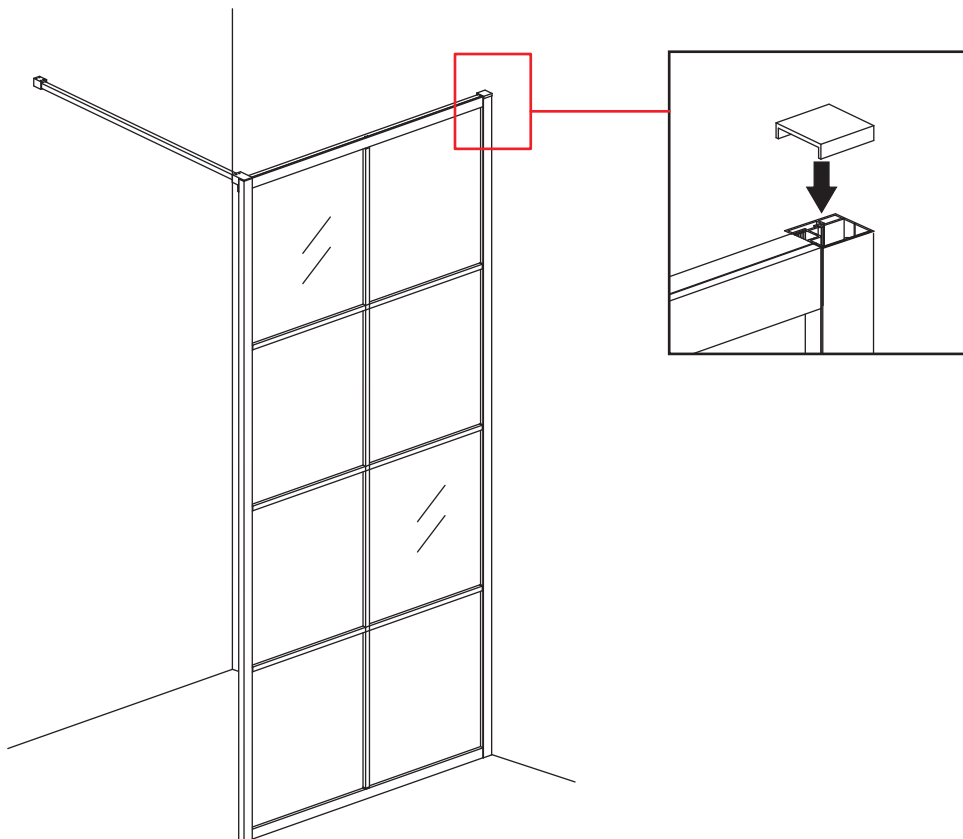

7

Make the glass gel then make sure without shower in 24hours.

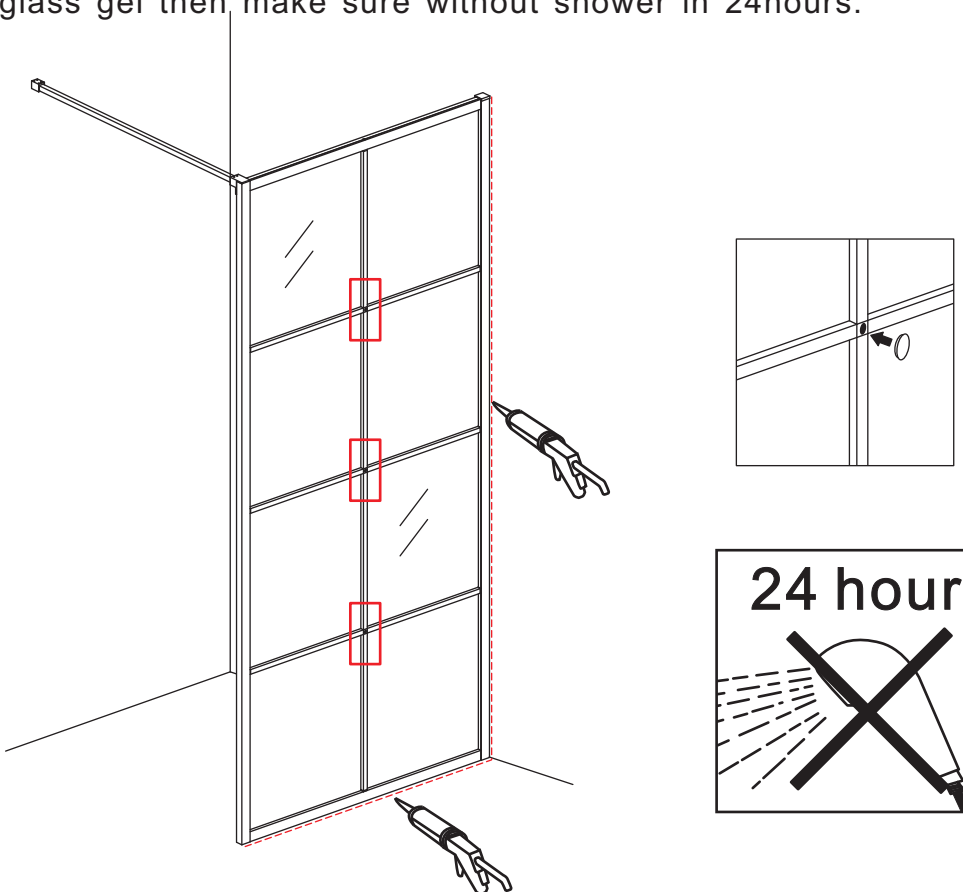

8